

KM-280/500MAH-E

SLIM-LINE MODULAR CRESCENT CUBER

Item # _____

Project: _____

Qty: _____

*AutoCad available on KCL

KM-280/500MAH-E

8/06

Item # 13125

CUBER DIMENSIONS

W x D x H

KM-280/500MAH-E
56 x 69.5 x 77cm

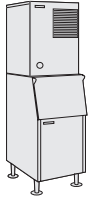

KM-280/B-300

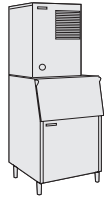

KM-280/B-500

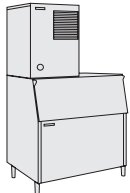

KM-280/B-700



KM-500/B-300



KM-500/B-500

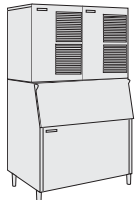

KM-500/B-700

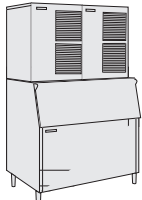

KM-500/B-800

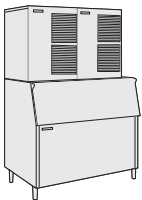

KM-500/B-900

Also available on Large Bins:
B-1150SS
B-1300SS



KM-280MAH-E

Air-Cooled
Shown

KM-500MAH-E

Air-Cooled



KM-280MAH-E

- Up to 117 kgs. of ice production per 24 hours

KM-500MAH-E

- Up to 218 kgs. of ice production per 24 hours
- Mount two units side by side for 436 kgs. per 24 hours

KM-280MAH-E & KM-500MAH-E

- Durable stainless steel exterior
- Individual crescent cube
- Protected by *HoshiGuard* Antimicrobial Agent 
- CycleSaver® Design 
- EverCheck® alert system 
- Stainless steel evaporator
- Removable air filters
- R-404A Refrigerant



Warranty

Contact factory for warranty information.



Hoshizaki

KM-280/500MAH-E SLIM-LINE MODULAR CRESCENT CUBER

DIMENSIONS
W x D x H
KM-280/500MAH-E
56 x 69.5 x 77cm

• Air-cooled

AIR-COOLED - KM-280MAH-E

Water Temp ° C.	10°	21°	32°	
Air Temp ° C.	21°	117	105	93
27°	108	89	79	
32°	105	75	64	

AIR-COOLED - KM-500MAH-E

Water Temp ° C.	10°	21°	32°	
Air Temp ° C.	21°	218	202	183
27°	206	182	163	
32°	202	166	146	

UTILITY CONSUMPTION at 32°C A/ 21°C W

Model Number	Ice Production Per Cycle		KWH per 45 Kgs.	Potable Water Liters per 45 kgs.	Condenser Water Liters per 45 kgs.
	Kgs.	Cubes			
KM-280MAH-E	2.16	240	11.6	133.6	N/A
KM-500MAH-E	4.3	480	6.7	154.4	N/A

SPECIFICATIONS

Model Number	Condenser	Amperage	Min. Circuit Ampacity	Shipping Weight
KM-280MAH-E	Air-Cooled	5.1	15 A	72.5 kgs.
KM-500MAH-E	Air-Cooled	5.5	15 A	79.5 kgs.

STORAGE BINS

Model Number	Application Capacity
B-300	136 kgs.
B-500	227 kgs.
B-700	318 kgs.
B-800	364 kgs.
B-900	409 kgs.
B-1150	522 kgs.
B-1300	590 kgs.

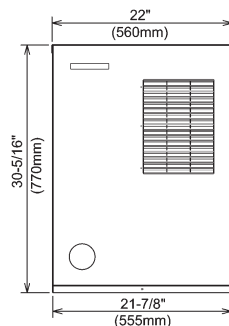

KM-280 FRONT VIEW

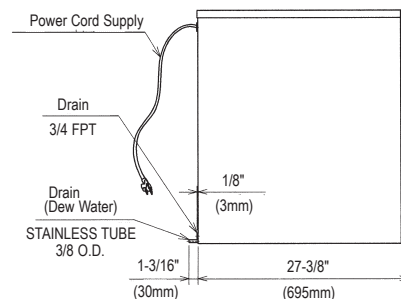

KM-280 SIDE VIEW

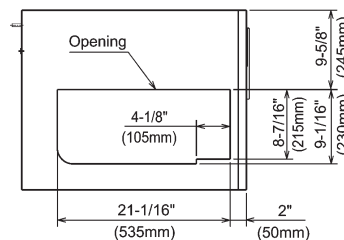

KM-280/500 ICE DROP ZONE

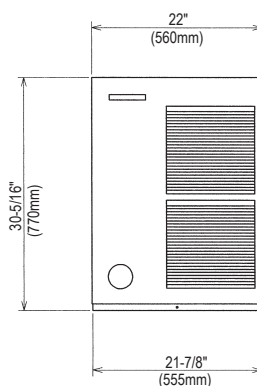

KM-500 FRONT VIEW

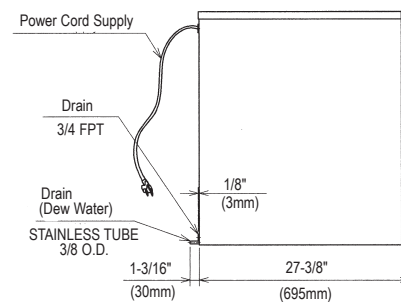

KM-500 SIDE VIEW

ELECTRICAL & PLUMBING/KM-280/500MAH-E

- 220-240/50/1
- 15 Amp Max Fuse
- 1.27cm OD copper or equivalent independent potable water supply
- 3/4" FPT independent drain connection

OPERATING LIMITS

- Ambient Temp Range 7 - 38°C
- Water Temp Range 7 - 32°C
- Water Pressure 0.7 - 8 kg/cm²
- Voltage Range 198 - 254V

SERVICE

- Panels easily removed and all components accessible for service.
- Removable/cleanable air filters



© HOSHIZAKI AMERICA, INC.

618 Hwy. 74 S., Peachtree City, GA 30269

TEL 1-800-438-6087

FAX 1-800-345-1325

www.hoshizaki.com

Printed in U.S.A.

